

TALYROND® 565/585 PRO

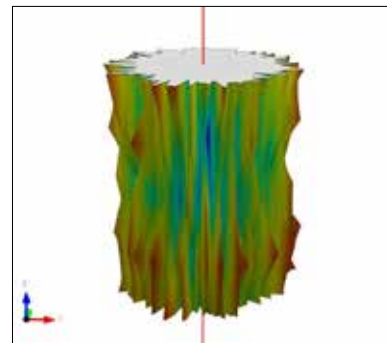
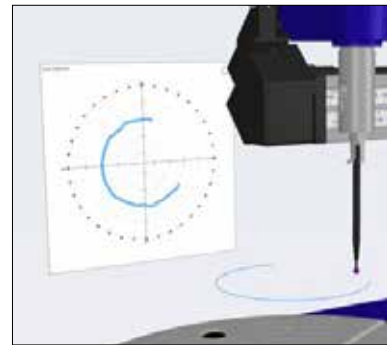

Ultra-high precision roundness measurement

TALYROND[®] 565/585 PRO

Advanced roundness metrology, made simple

High fidelity measurement

Critical to any measuring instrument is the stability of its metrology frame. Taylor Hobson's expertise is in producing extremely low noise, high resolution instrumentation that guarantees measurement integrity.

We are so confident in our measurement capability that every instrument comes with static noise measurement, in fact, Taylor Hobson were the first and are one of the only roundness manufacturers that state noise levels.

When you purchase from Taylor Hobson, you are investing in the most accurate, stable and repeatable measurement system on the market.

One software platform, multiple disciplines

-  Roundness
-  Roughness
-  Contour
-  Topography

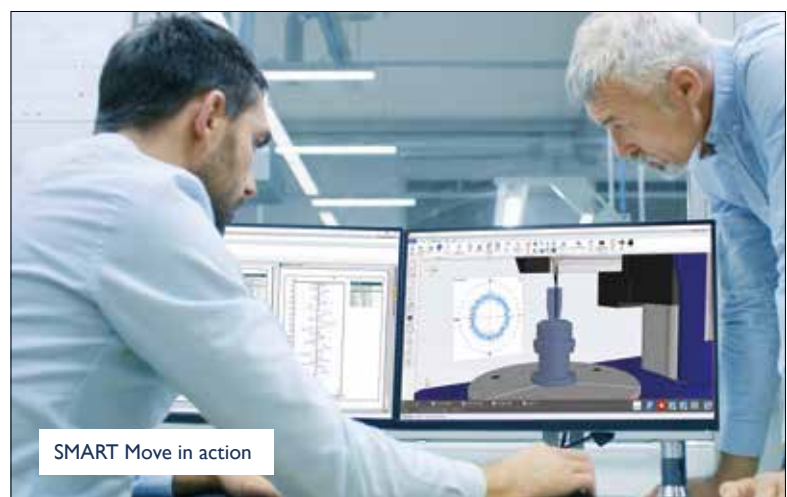

Gauge



Gauge range, up to
4 mm

Resolution, down to
0.3 nm

Roundness



Radial accuracy
 $\pm 0.01 \mu\text{m}$

Roughness



Noise
< 30 nm Rq all axes

Ra values
< 0.1 μm Rq

Contour



LS Arc measurement
5 μm

Pt
0.5 μm

TALYROND®
powered by



Metrology 4.0®

SMART SOFTWARE

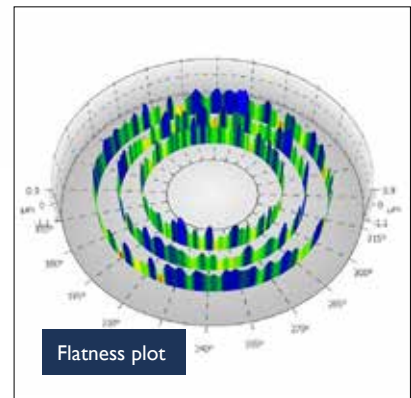
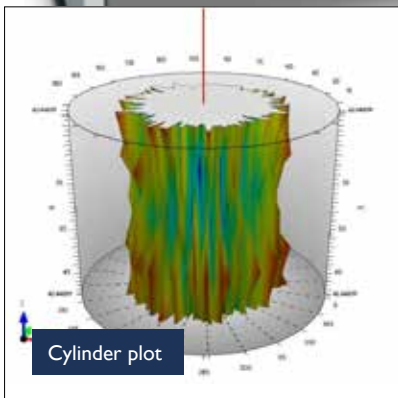

SMART SOFTWARE

Cutting-edge technology

Unique benefits for both design and production

 **Roundness**

Frictionless high precision air bearing spindle provides world leading roundness results

 **Surface Texture**

High resolution gauge and low axis noise enables linear or circumferential surface roughness

 **Contour**

Our patented calibration technique enables measurement of radii, angle, height, length, distance and more

 **Topography**

A fully automated routine enabling 3D topography of cylindrical surfaces

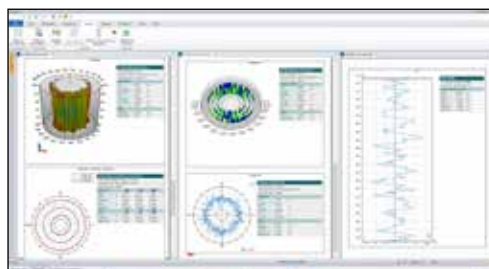
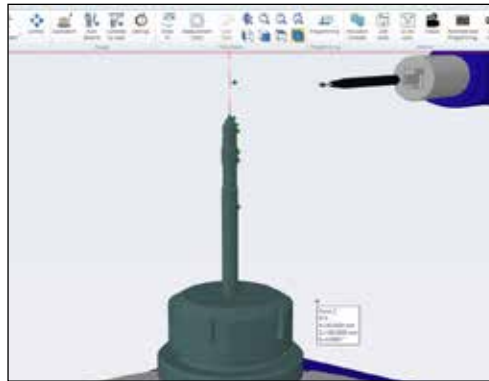
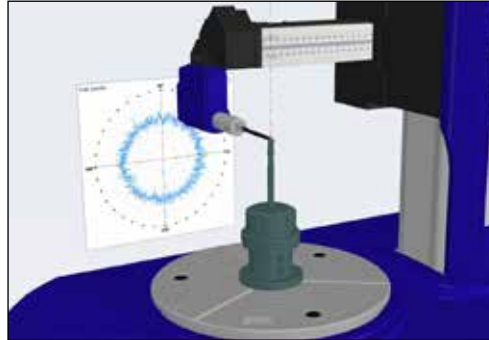

Class-leading

 **Range & Resolution**

 **Noise**

 **Roundness**

 **Flatness**

 **Straightness**

Metrology 4.0 - Smart Software

The advancement in metrology software design that the market has been waiting for...

Taylor Hobson's advanced software enables dimensioning in accordance with part drawings and provides an exact reflection of the Part Co-ordinate System (PCS) delivering the final link in the manufacturing loop.

Metrology 4.0 software is easy to use with an intuitive user-interface, virtual display and real time control. The state-of-the-art point and move axis control function delivers precise positioning and accurate measurement.

" Metrology 4.0 is a quantum leap
in measurement and analysis "

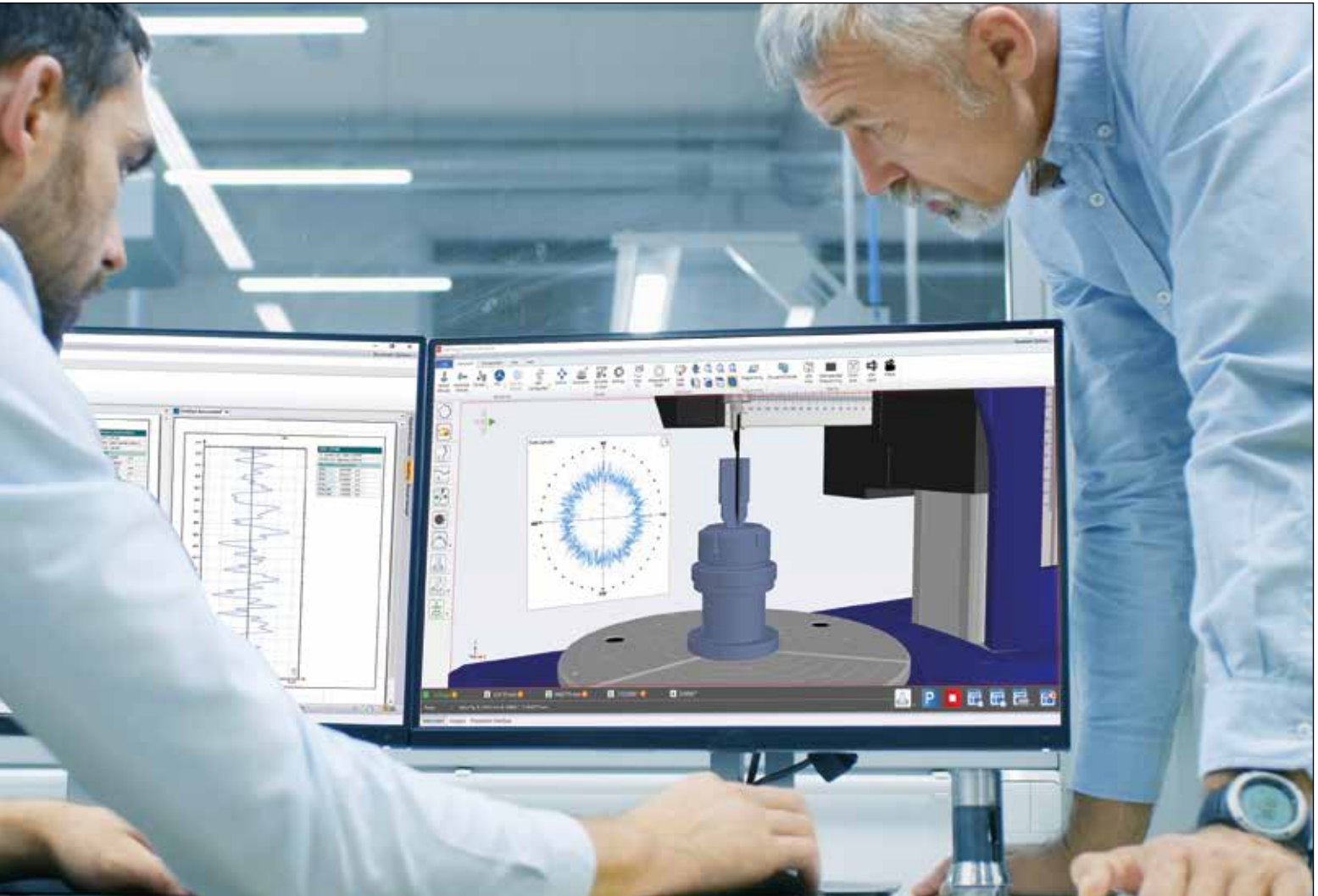

Industry 4.0 in action

All of the critical components for the Talyrond® 500H PRO are manufactured in-house at our UK facility, with unique serial numbers for worldwide traceability.

Taylor Hobson has invested in the latest machining techniques to deliver measurement integrity through manufacturing excellence.



"Our strong investment meets the demands of high technology manufacturing"

**Tim Garner, Operations Director.
– Taylor Hobson Ltd.**

Taylor Hobson's latest investment includes the Mazak Integrex i-200S with 10 axis, twin spindle, in cycle probing, tool break detection, unmanned running, temperature control, zero set up times, auto re-loading, high accuracy glass scales and 110 tool capacity.

SMART FACTORY

Industry 4.0 supported by Metrology 4.0

The future of modern manufacturing

Industry 4.0 philosophy is driving what has been called a 'Smart Factory' through the process of automation, data exchange and control in manufacturing environments.

A "Smart Factory" includes a variety of modern technologies such as, Internet of Things, Internet of People, Cloud computing, Smart sensors and Advanced SPC software.

Taylor Hobson's ongoing developments support this approach and are in line with the Industry 4.0 philosophy. Metrology 4.0 software includes an intuitive, easy-to-use and modern Production Interface.

The Q-DAS accredited production interface is designed for shop floor environments and provides direct communication with SPC software, which delivers feedback to your manufacturing process.

This form of monitoring is used widely in automotive and aerospace manufacturing, where traceability and strict standard operating procedure control are mandatory.



Programs reduce operator mistakes



Programmed measurement routines reduce cycle times and increase throughput



Display traceable pass/fail results and automatic summary reports



Tolerancing - Visually identifies the parameter and tolerance band



Historic traceability is made possible via data exchange and part tracking



Control can be managed by barcode scanners or tracking/auditing system



Statistics such as automatic R&R studies



Taylor Hobson metrology directly monitoring production

Modern manufacturing cycle

1. Innovative design
2. State-of-the-art manufacturing
3. Fast and automated part-handling
4. Measurement and analysis powered by Metrology 4.0
5. Feedback of results to data centre for trend analysis
6. Monitor trends in the field or in production
7. Improve quality and efficiency

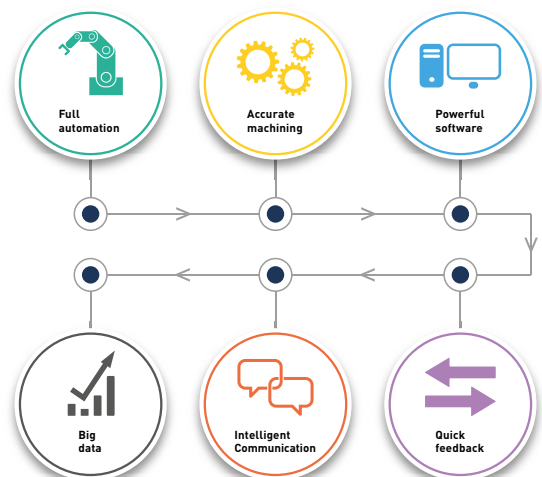

SMART

So much more than a roundness instrument

☑ Centre & level

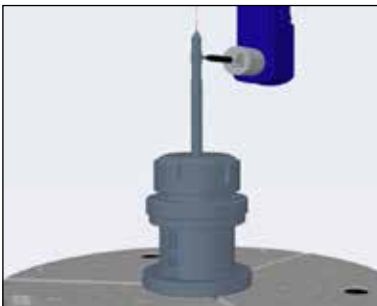

Another first is the unique three-point centre and levelling method which provides a stable and high-load capability.

Precise positional control combines with predefined alignment positions to produce the fastest centre and levelling device on the market.

This feature is ideal for high production volume environments where fast feedback is critical.

☑ Automated axis calibration



A simple automated routine that allows the user to set all axis positions without manual entry, removing operator error and ensuring positional consistency when programming.

☑ High precision velocity mode

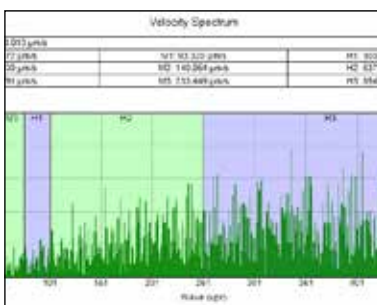

Velocity analysis is a tried and tested facility for assessing low noise, high precision bearings and other precision rotational surfaces.

A critical element when looking at velocity, harmonics and none round components such as camshafts is the high resolution encoder. This ensures exact replication of harmonic frequencies and form on bearings, camshafts and other rotational components.

Centre and Level -
Completed in less
than half the time



UNIQUE

Cutting-edge technology

Gauge range and resolution



The world-leading gauge delivers 4 mm of range, twice the range of most roundness instruments. This enables the unique capability of roundness, contour, and roughness measurement from a single gauge.

This universal gauge has a resolution down to 0.3 nm, when coupled with the system's low noise platform, the Talyrond® 500H PRO becomes a fully automated surface texture instrument.

Gauge orientation



Taylor Hobson's patented method of gauge automatic attitude/orientation* combined with the "any attitude" Talymin 6 gauge ensure easy access the most complex of components.

The breakaway stylus has a naturally long reach and therefore rarely requires elongation; this extra reach is available in both horizontal and vertical modes.

Follow mode



Follow mode is possible using the Radial Straightness Unit, this ability to track the surface of the part allows measurement of tapers, splines, camshafts, CV joints and much more.

Comprehensive analysis can be made on circular or straightness profiles utilising the powerful Advanced Contour software.

*Talyrond 565 PRO has manual attitude/orientation.

Powerful Software -
Giving confidence in
your instrument

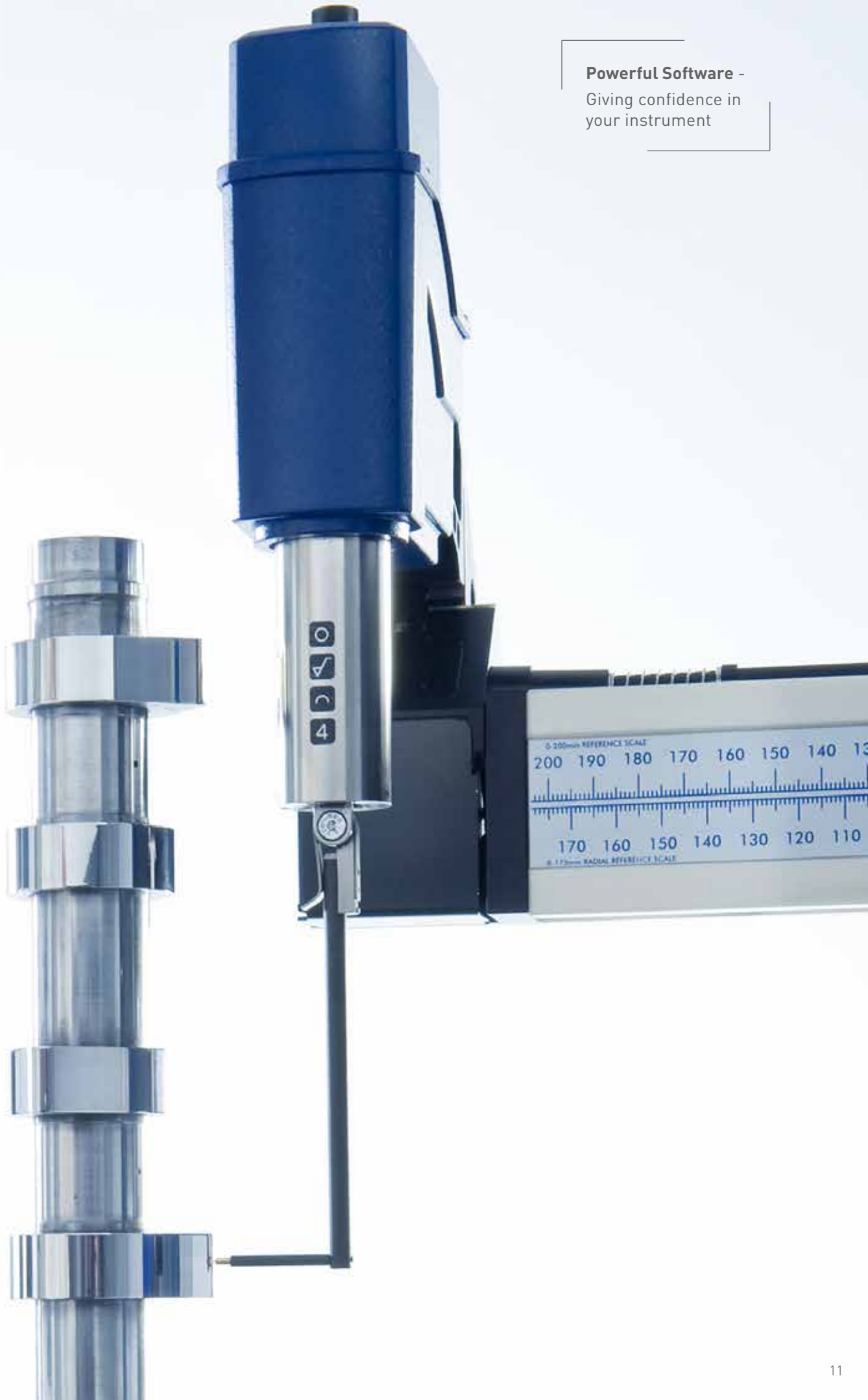

AUTOMATION

Precise and fast instrument control

✔ SMART Move and CAD models

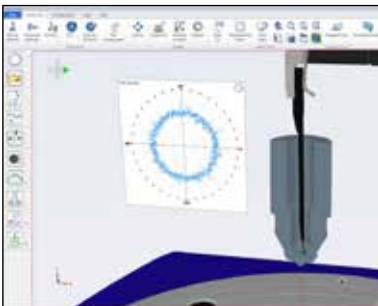

A powerful utility that enables online and offline programming around a CAD model. Features include a stylus tip “flight path” enabling collision detection.

The Metrology 4.0 visual display is an exact replica of the real instrument; seeing is believing. Measurements are made between pre-defined points or from points fed back from the analysis process. Improved accuracy and repeatability can be achieved via the unique feedback process.

✔ Low coning error

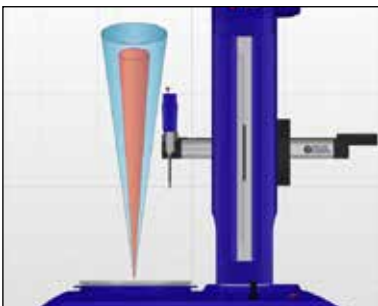

The smaller the coning error of any instrument the more reliable the results. In fact, coning error is the single biggest source of error when measuring cylindricity, parallelism and roundness of tall components.

It is a source of error often overlooked or written in the small print, this is not so with the Talyrond® 500H PRO which has the one of the lowest coning error on the market.

✔ Crutch angle correction and automatic gain calibration

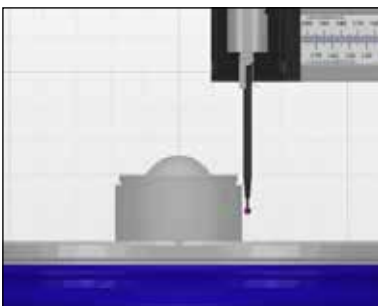

A simple approach to gauge calibration that literally takes seconds to do. Utilising the instrument high precision scales this procedure calibrates both the gauge gain and crutch angle position in a single user guided operation.

All subsequent movements of the gauge attitude orientation are updated to ensure corrected stylus tip position between the virtual and real instrument.

Talyrond® 500H PRO -
Designed for metrology
without compromise

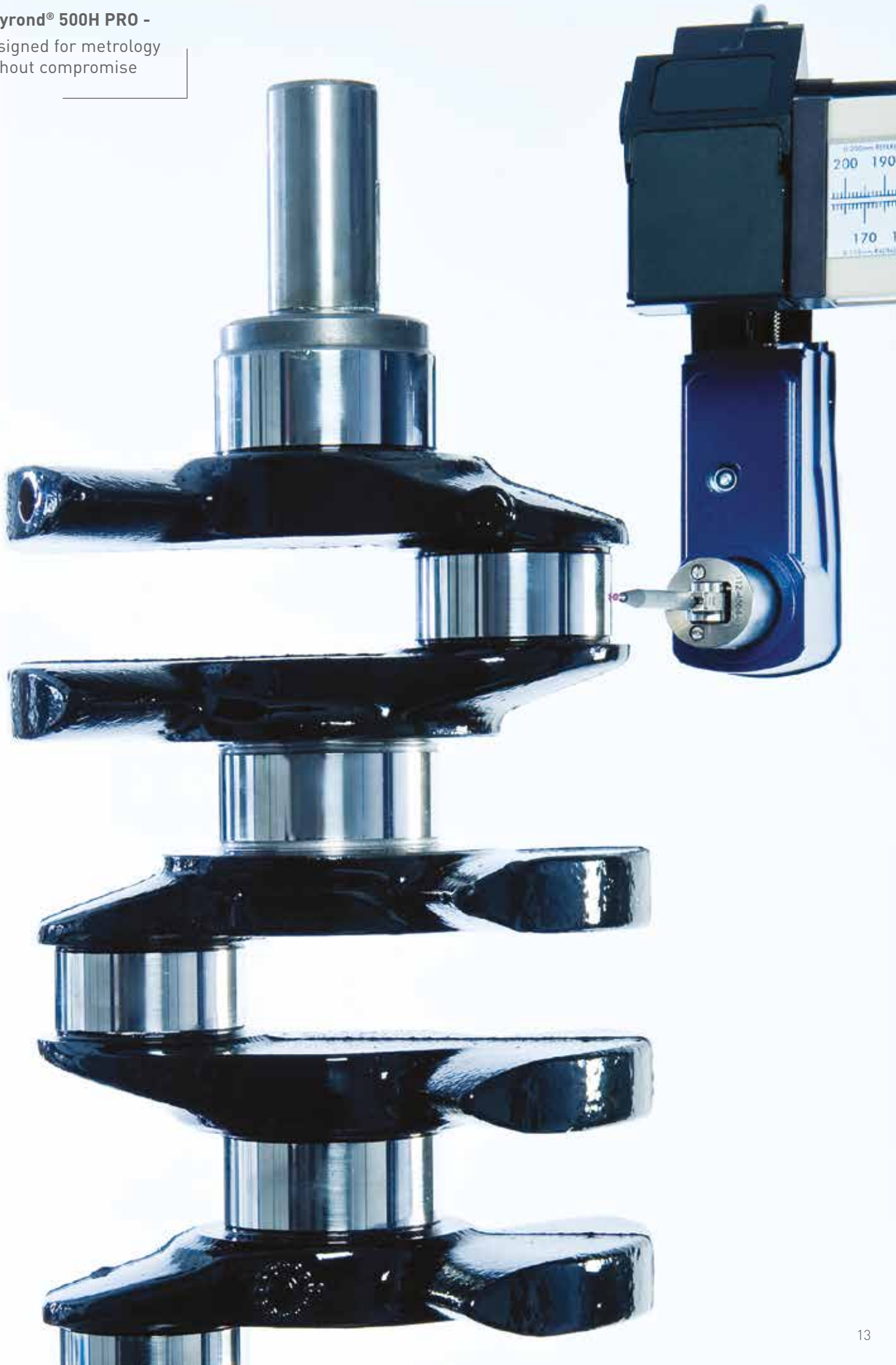

SOFTWARE

Best-in-class metrology software

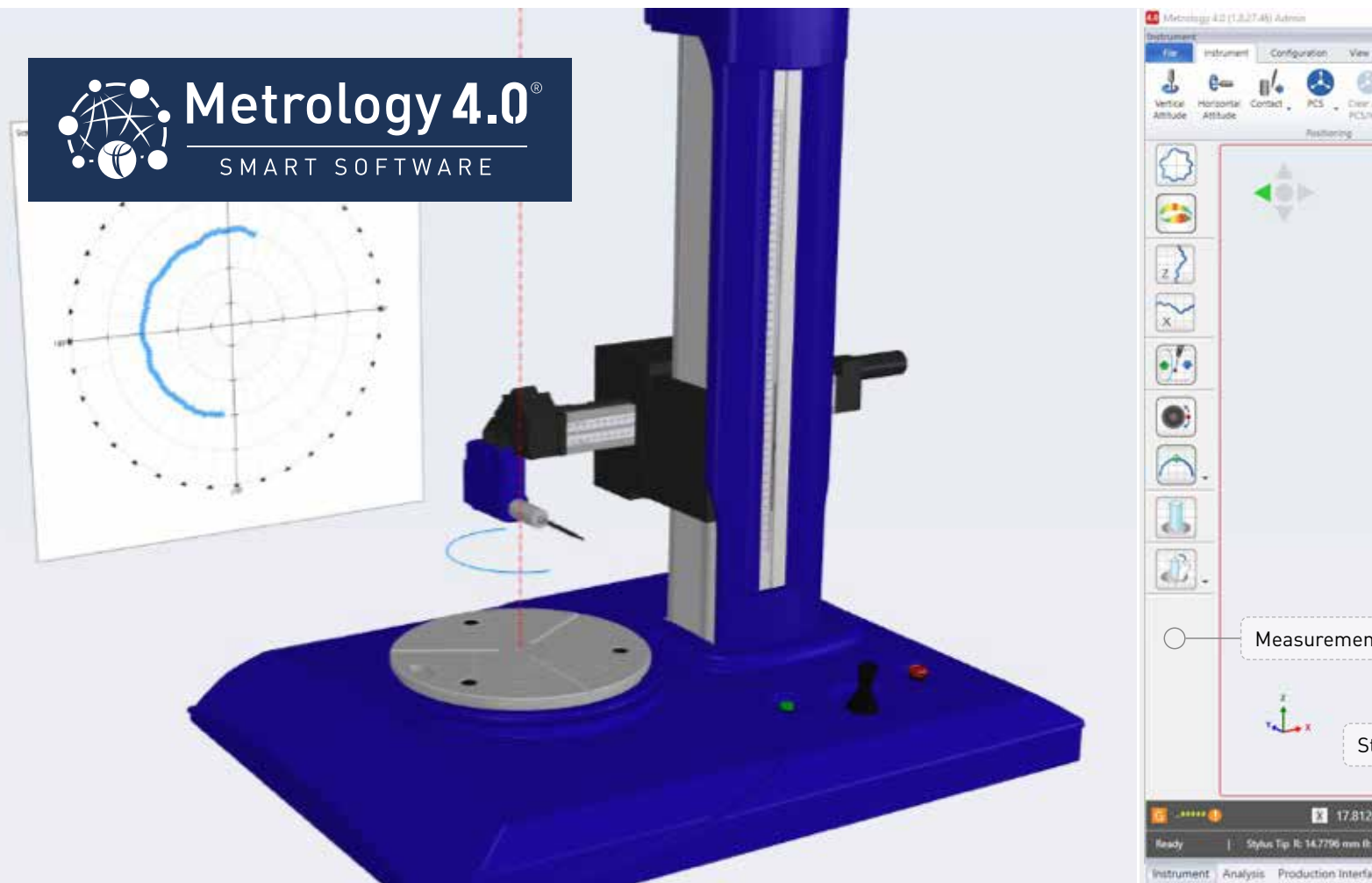

✔ Part Co-ordinate System

Metrology 4.0 has two co-ordinate systems; instrument and part.

The Part Co-ordinate System (PCS) allows the user to control measurement and movement around any component according to the part drawing.

The on-screen view provides an exact simulation of the real instrument, allowing remote monitoring and at a glance confidence in the measurement process.

✔ Calibration

One hit patented calibration routines provide accurate and precise measurements.

These routines are fast and do not require operator intervention ensuring maximum performance.

Media Messages - Include text, images and videos as operator prompts during programs

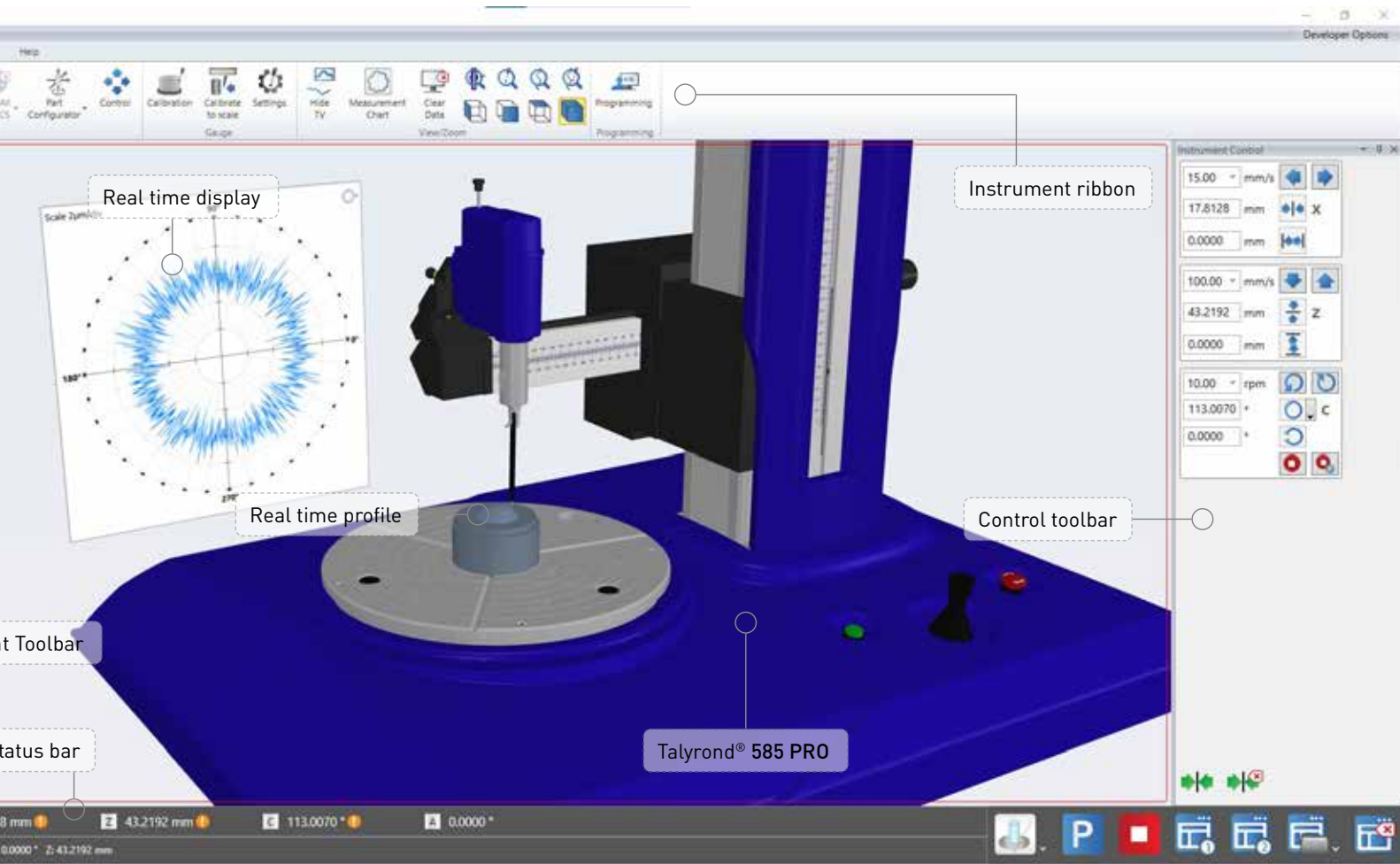

✓ Programming

A range of different modes that offer basic elements such as recordable part programming and an advanced toolbox of programmable features including variables.

The use of variables reduces the time it takes to create and maintain multiple part programs. This function allows one program to be created for a set of parts of differing sizes.

✓ Macros

A new software feature that enables the user to define icon-based functions. These functions can be set to run custom measurement programs, media messages, instructions, warnings, calibration routines, and much more.

The user has instant and configurable access to all macro functions directly from the instrument control ribbon.

SOFTWARE

Designed with the operator in mind

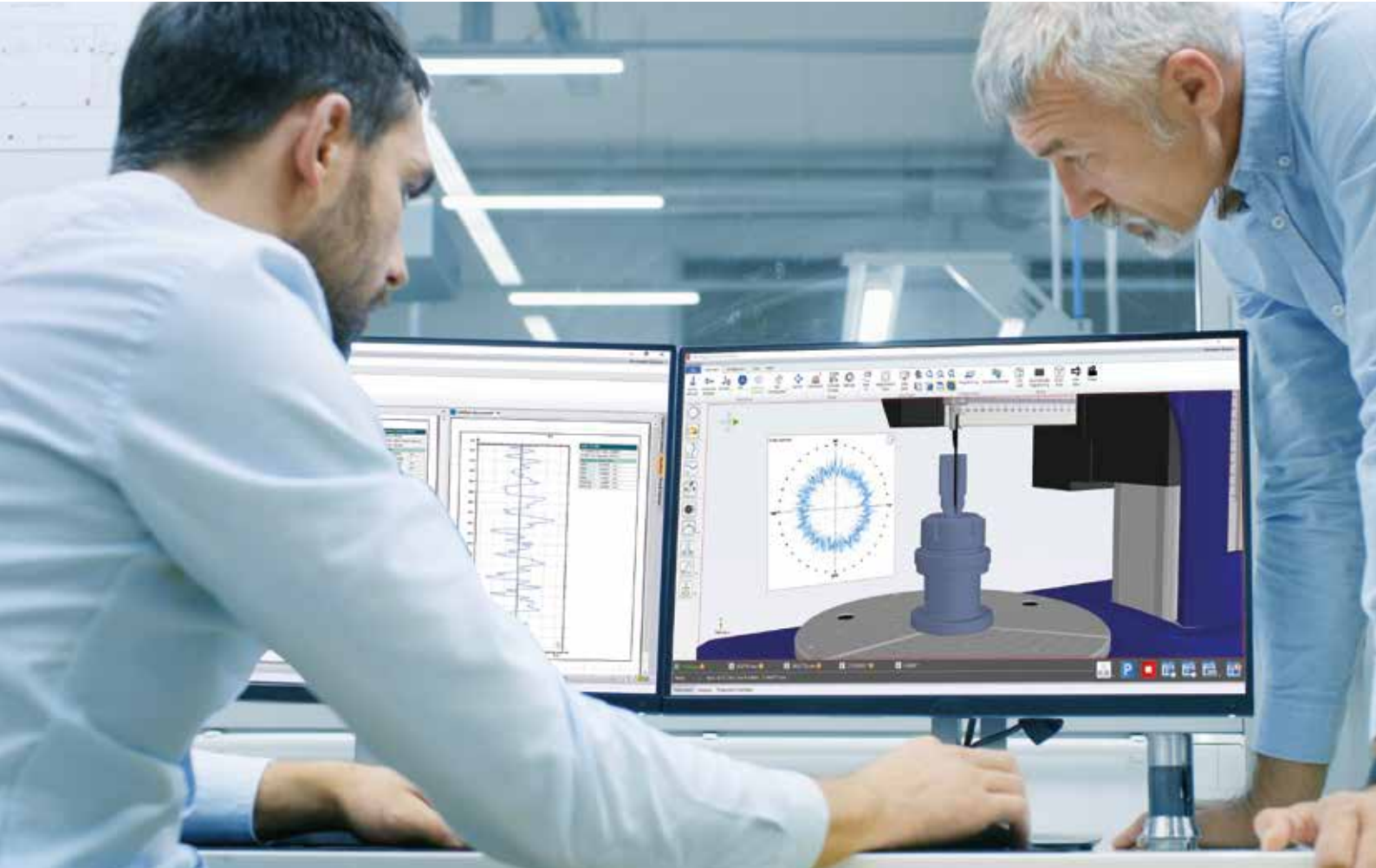

SMART Move

Simply click on the screen to create a point and the instrument will then move the stylus tip to that point. The instrument moves using either the traverse, column or a combination of these axes. A pre-flight path allows the user to predict and control the axes of movement to avoid any obstructions.

Measurements are made between pre-defined points or from points fed back from the analysis process. Improved accuracy and repeatability can be achieved via the unique feedback process.

- Program around CAD models
- Collision Prediction
- Pre-flight path visualisation
- Simple click and move to position
- Fully programmable
- Define part coordinates from measured features

SMART Move - A perfect tool for online and offline programming



✔ Icon-driven interface

Metrology 4.0 enables simulation of the measurement process with 'at-a-glance' status, on-screen indicators, real-time feedback and remote system control.

A range of different measurement modes are available via intuitive icons on the measurement tool bar. Tool tips give a detailed overview of the measurement.

✔ User levels

The password protected modes provide complete control of a user's access, resulting in a tamper-proof software interface for use in the most secure environments.

ANALYSIS

One software platform, multiple disciplines

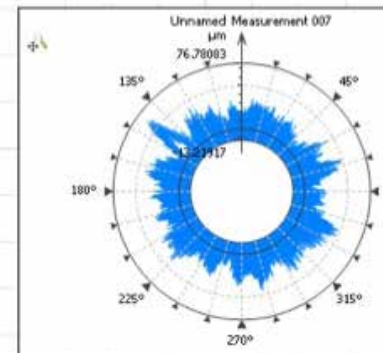
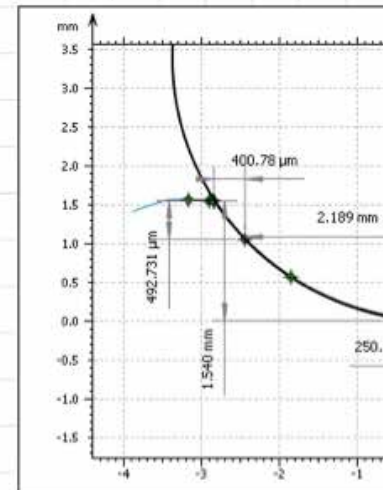
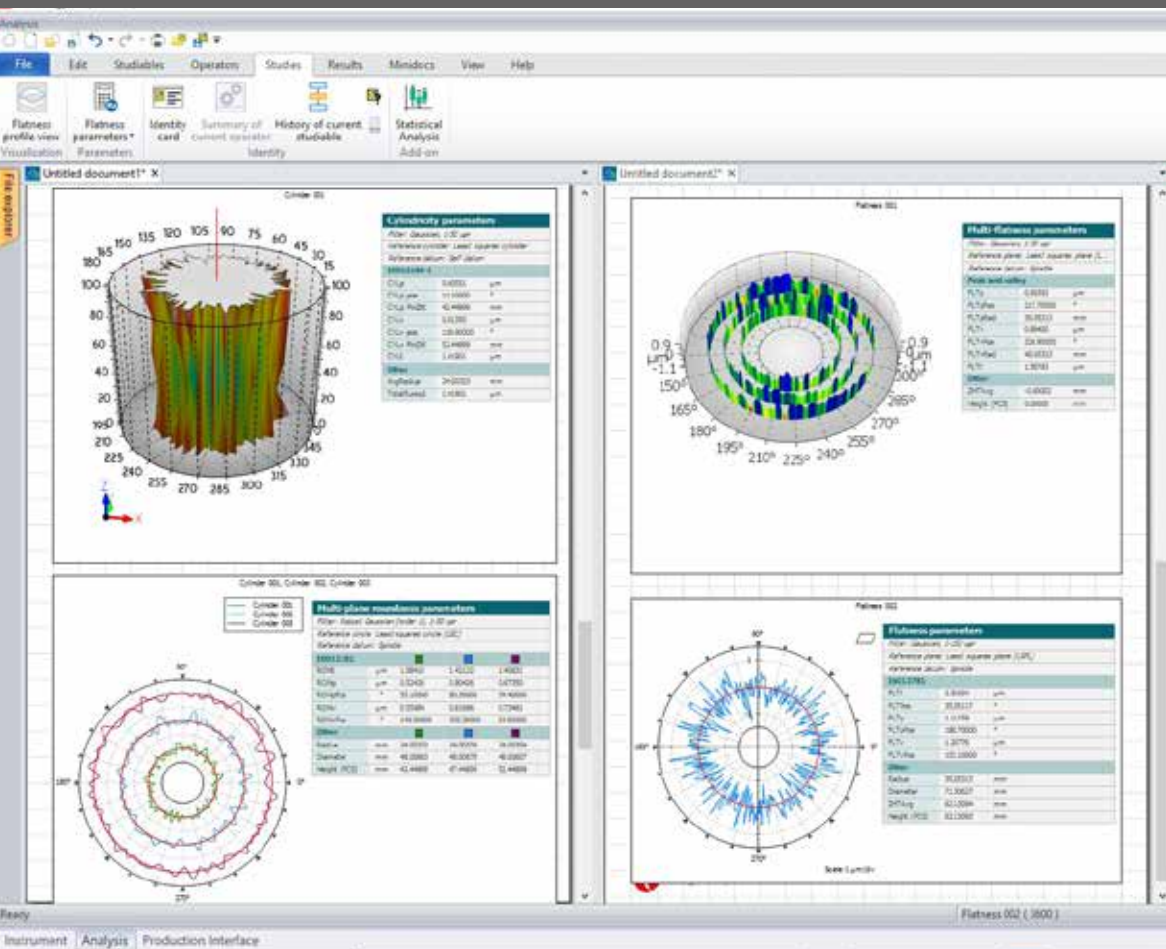

Roundness

A complete roundness system capable of cylindricity, flatness, straightness, parallelism and much more.

Contour

An essential tool for geometric dimensioning, tolerancing of profiles and full form deviation analysis.

Save time and increase productivity with automation features within Contour analysis.

Topography

Transform your 2D measurement into a powerful 3D analysis to view the surface in greater detail using Metrology 4.0 Analysis 3D software.

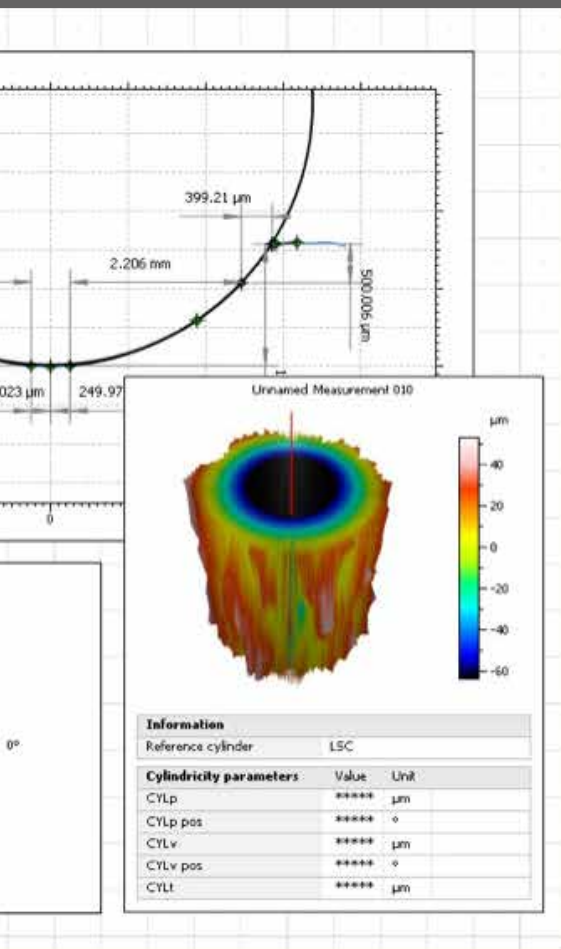

Crown Long In Contact 20	
ASME B46.1 - Roughness profile (S-L)	
<i>F: Leveled (LS), Angle -0.00304°</i>	
<i>λz Filter: Gaussian, 2.5 μm</i>	
<i>λx Filter: Gaussian, 0.8 mm, 1/2 cut-off</i>	
2D parameters	
Rt	1.30309 μm
Rp	0.23152 μm
Rv	1.07157 μm
Rz	0.56448 μm <i>Alt Ac (29)</i>
Ra	0.05886 μm
Rq	0.08448 μm

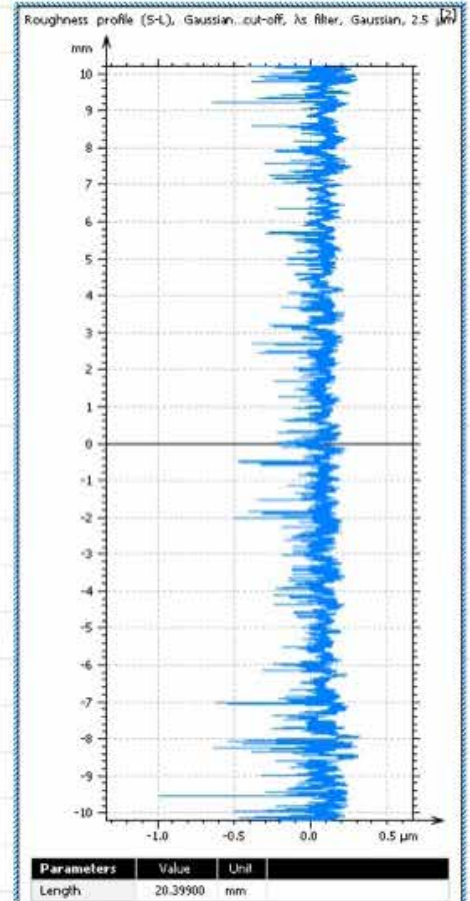
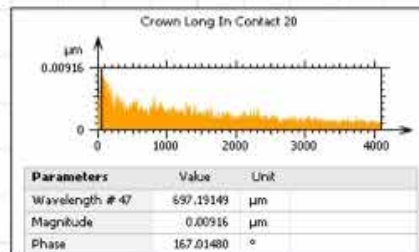
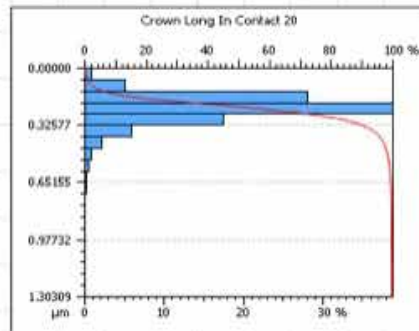

✓ Surface texture

The Talyond® 500H PRO has the lowest noise platform and the highest resolution gauge, enabling roughness measurement to a level normally associated with surface texture instruments.

✓ Critical analysis types

- Twist measurement
- Harmonic analysis
- Velocity analysis
- Ballscrew measurement
- Wall/disc thickness
- Cam measurement
- Angle measurement
- Dual profile
- Data fusion
- Circumferential surface texture
- Profile patching

DESKTOP PUBLISHING

Quick, simple and professional

Desktop publishing

The desktop publishing features are powerful and simple to use allowing customisation of result layouts and ensuring a more professional and personalised look to your brand.

The software allows users to create templates and use them in the analysis process, which vastly simplifies the measurement process.

- Generate interactive reports
- Compose multi-page documents
- Multiple documents can be displayed on screen, which enables visual comparison of multiple results at once
- Build a professional report in a matter of minutes
- Include corporate logos
- Create certificates



Customised analysis

Our strategy for success is simple, instead of just selling products, we provide solutions. If our standard software analysis packages do not satisfy your needs, we can customise a solution to match your requirement as an advanced module.

Alternatively Metrology 4.0 has built-in access to execute MATLAB™ files*. This enables the user to writing their own scripts and execute them by loading an 'm' file.

Design and program your own custom filters, analyses and parameters.



Professional Desktop Publishing

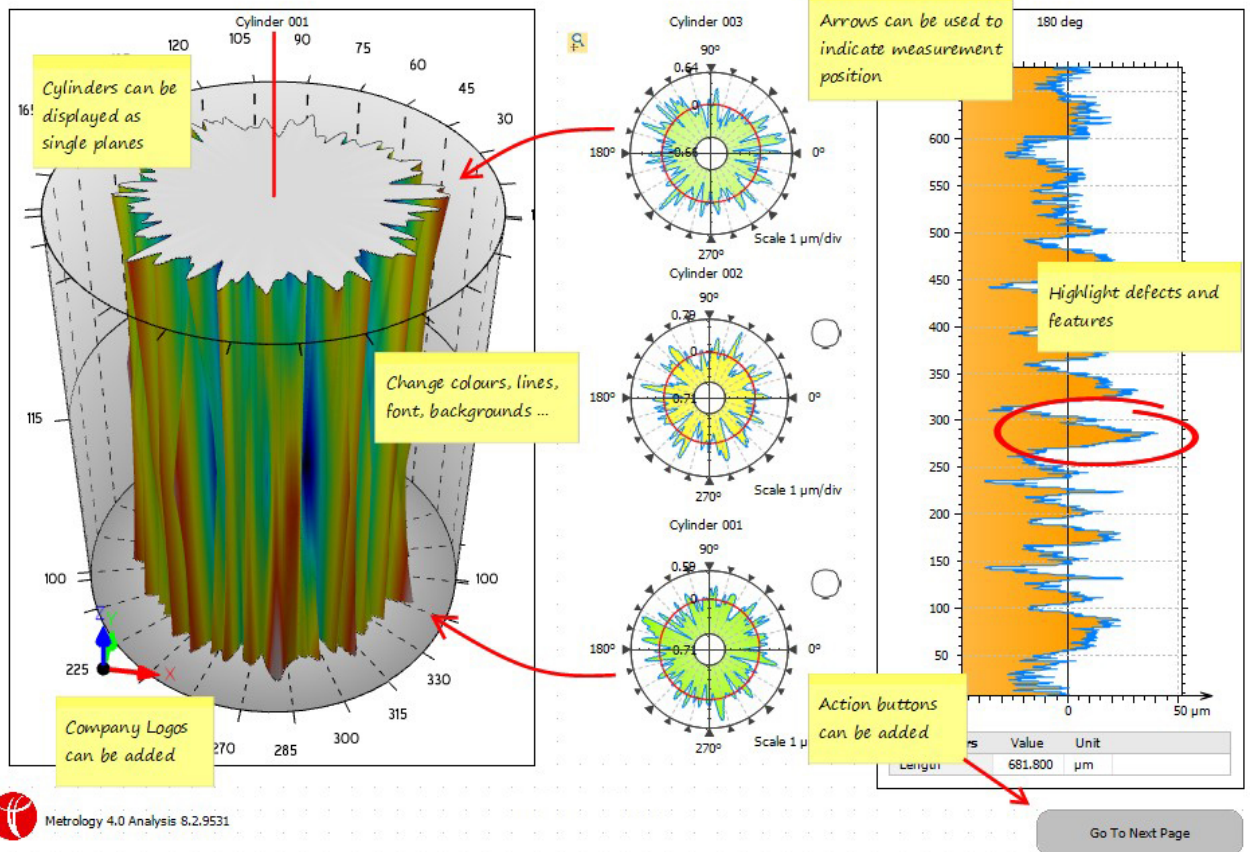

Feedback measurement control

Repeatability and reproducibility are key to any production process. Metrology 4.0 closes the loop between measurement and analysis by feeding back positional information to the movement or measurement process in order to improve process control.

Repeatability and reproducibility are key to any production process; the same is true for the measurement process.

Movements and measurements can be controlled by defined features on a part such as intersections.

- Measure profile
- Create datum points for critical features
- Add datum points to instrument view
- SMART Move to start position
- Measure between specified points
- Apply template to the analysis

* MATLAB™ software purchased separately from external source.

APPLICATIONS

Unparalleled measurement capability

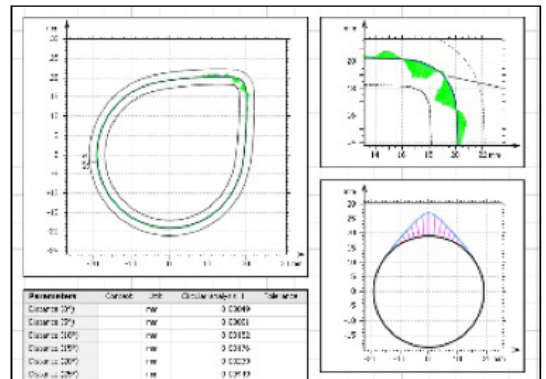
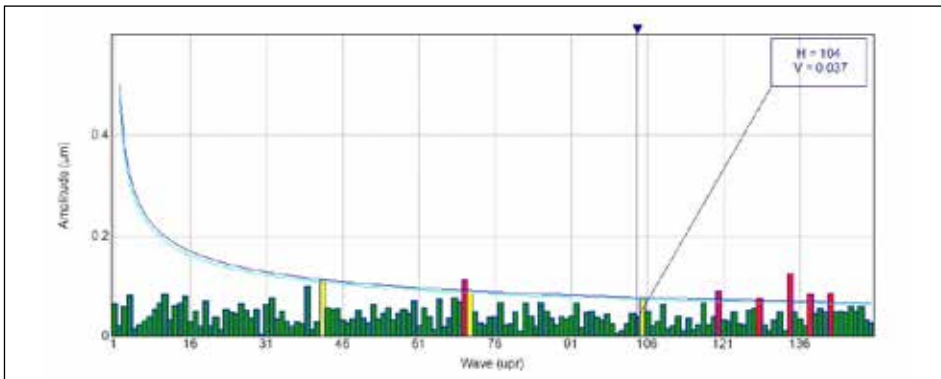
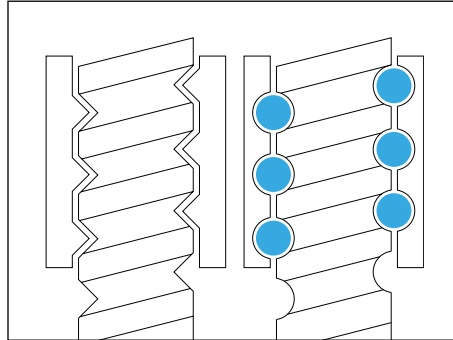

✓ Ball screw

The Talyrond® 500H PRO provides measurement along the full length of the contact point of the ball screw or lead screw.

High precision control and low noise on all the instrument's axes enable analysis of harmonics and roughness and help towards ensuring smooth operation of the ball screw.

✓ Camshafts

The instrument's radial straightness unit and high precision spindle allow measurement of a cam profile. Subsequent analysis can be done using Taylor Hobson's Advanced contour software, enabling comparison to a DXF or lift data.

Other features of the contour software include surface texture and harmonic analysis.

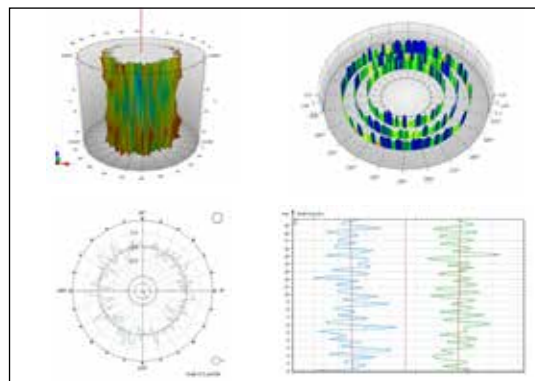
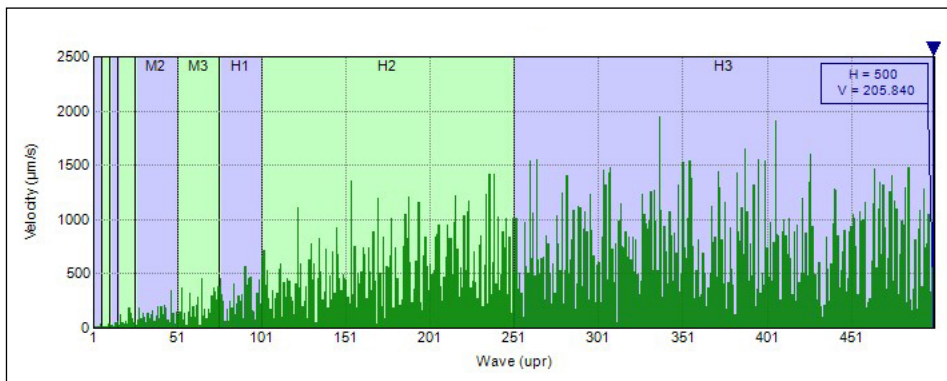
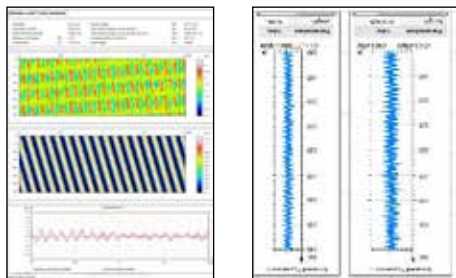
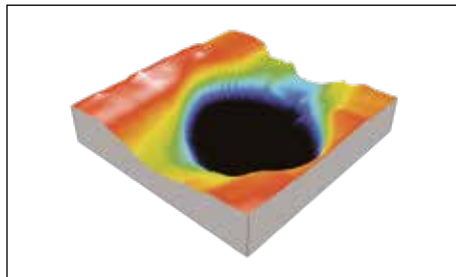
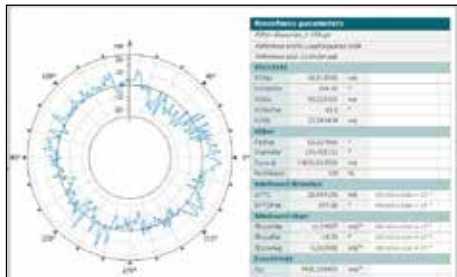

✓ Bearing races

The Talyrond[®] 500H PRO frictionless air bearing spindle has been developed to allow measurement of roundness and just as importantly harmonic analysis.

In fact every Talyrond 500H PRO[®] is extensively tested for harmonic noise to ensure results are from the part and not induced by the instrument.

✓ Crankshafts

The instrument is truly universal and capable of not just roundness, straightness and cylindricity but also parallelism, twist, surface texture and the 3D topography of features such as oil hole washout.

APPLICATIONS

Buy with confidence

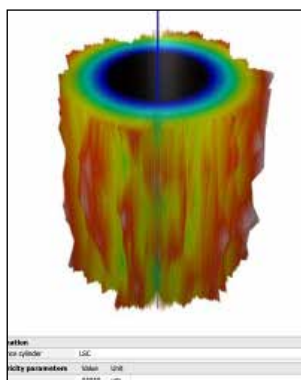
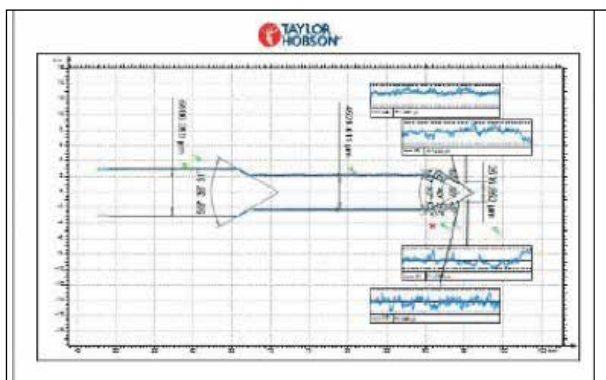
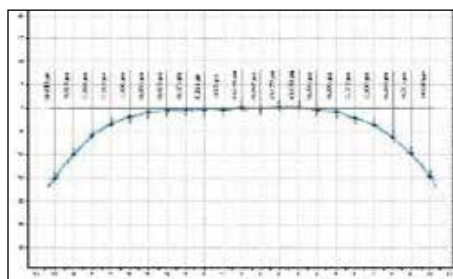
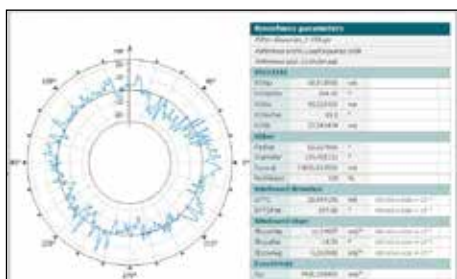
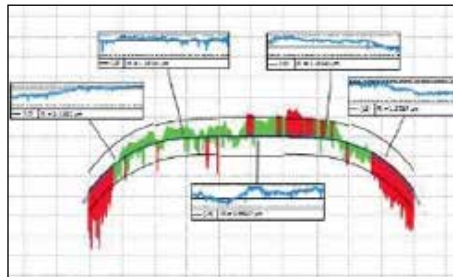

✓ Roller bearings

Low noise, precision straightness and a high-resolution gauge enable measurement of roller bearings.

This allows control of roughness, form, and roundness as well as providing part alignment information relating to the machine tool such as tilt, parallelism and offset.

✓ Fuel injectors

Measurement capability normally associated with the Form Talysurf® PGI NOVUS such as seat angle, seat surface texture and seat straightness can be evaluated along with standard parameters such as parallelism, straightness, roundness, runout and much more.

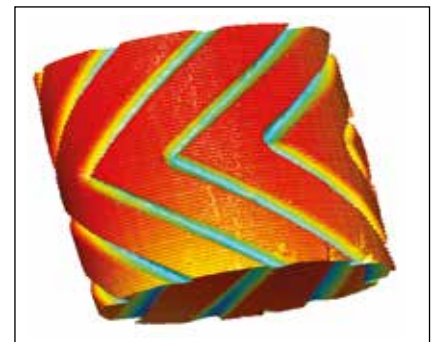
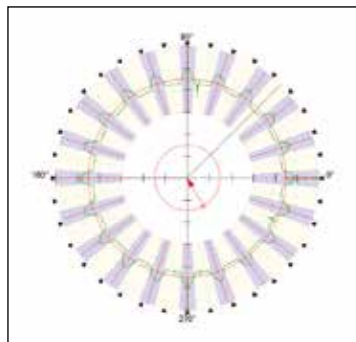
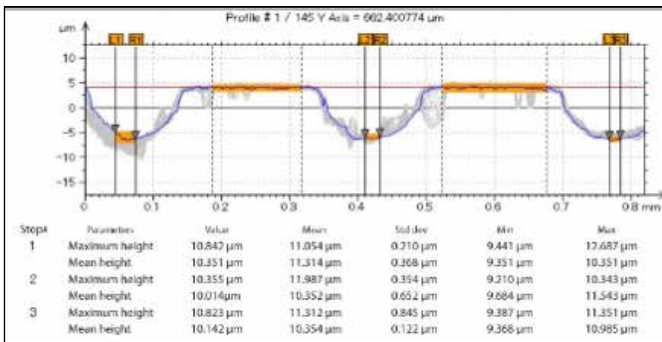
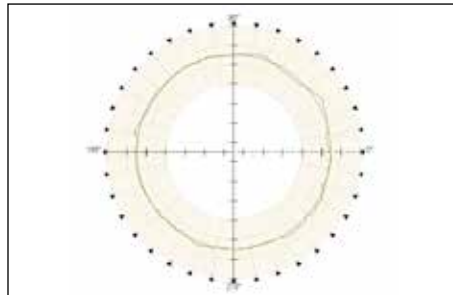

✓ Ball bearings

Electric Vehicle technology and the drive for efficiency and lower emissions have had a huge influence on bearing manufacture.

In order to achieve these criteria, bearings are becoming more precise, pushing the boundaries of instrument capability.

The Talyrond® 500H PRO has the lowest noise floor on the market however this new high precision mode will reduce the noise even further ensuring high integrity results for Harmonics, Velocity and surface finish measurement.

✓ Fluid dynamic bearings

The instrument can measure over 500 roundness planes with as little as 5 μm separation and up to 72,000 data points. The subsequent results can be analysed for roundness, topography and roughness as well as critical elements such as groove to width ratio and groove depth.

TRACEABILITY

Critical results, trust Taylor Hobson

Full traceability to international standards

Taylor Hobson provides full certification for artefacts and instruments in our purpose built ISO graded clean room UKAS facility.

Our UKAS laboratory is able to measure all of the parameters associated with surface texture, including French, German, USA and Japanese derivatives.



✓ Roundness

Using a precision polished glass hemisphere calibrated to an uncertainty of less than 5 nm Taylor Hobson can guarantee your spindle is within specification and maintain quality of results.

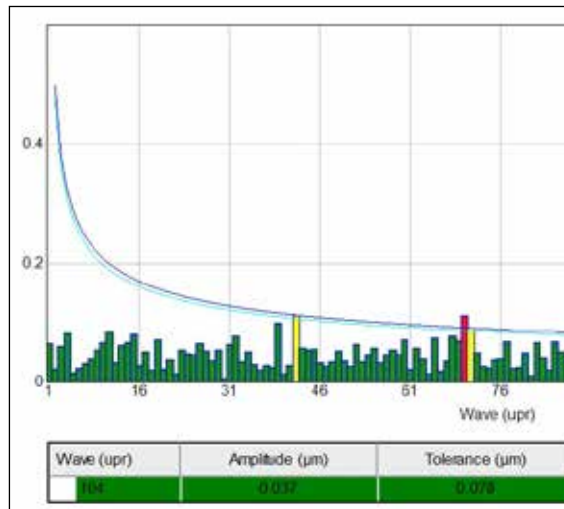

✓ Surface texture

A unique standard is available that provides measurement traceability for roughness in both a vertical and circumferential direction.

✓ Contour

Taylor Hobson's patented calibration routine and calibration ball corrects for the arcuate motion of the stylus allowing dimensional measurement.

This routine is critical to measurement of radius and angled parts when normal calibration routines will not suffice.

✓ Harmonic standard

Taylor Hobson are the only instrument manufacturer that offer a harmonic standard with harmonics from 15 - 1500 upr.

This standard gives you confidence in your results.



0026

2624



Automated probe calibration

The Talyrond® 500H PRO has a unique automated gain calibration for the instrument's gauge; the routine is automated and takes a matter of seconds to set.

Alternatively a set of calibrated slip blocks traceable to primary standards are also supplied.



Straightness, squareness and parallelism

To ensure the column and radial straightness unit conform to specification we can provide standards that are either cylindrical or flat. These standards provide certainty of the measurement axes.

These artefacts are combined with special software routines to enhance all axes for correct geometrical form.

The Metrology Experts

Established in 1886, Taylor Hobson is the world leader in surface and form metrology and developed the first roundness and surface finish measuring instruments.

www.taylor-hobson.com

Sales department

Email: taylor-hobson.sales@ametek.com

Tel: +44 (0) 116 276 3771

- **Design engineering** – special purpose, dedicated metrology systems for demanding applications.
- **Precision manufacturing** – contract machining services for high precision applications and industries.

Centre of Excellence department

Email: taylor-hobson.cofe@ametek.com

Tel: +44 (0) 116 276 3779

- **Inspection services** – measurement of your production parts by skilled technicians using industry leading instruments in accord with ISO standards.
- **Metrology training** – practical, hands-on training courses for roundness and surface finish conducted by experienced metrologists.
- **Operator training** – on-site instruction will lead to greater proficiency and higher productivity.
- **UKAS calibration and testing** – certification for artifacts or instruments in our laboratory or at customer's site.

Service department

Email: taylor-hobson.service@ametek.com

Tel: +44 (0) 116 246 2900

- **Preventative maintenance** – protect your metrology investment with an AMECare support agreement.



© Taylor Hobson Ltd. 2021



Taylor Hobson UK

(Global Headquarters)

PO Box 36, 2 New Star Road
Leicester,
LE4 9JQ,
England

Tel: +44 (0)116 276 3771
taylor-hobson.sales@ametek.com



Taylor Hobson France

Rond Point de l'Épine Champs
Batiment D, 78990 Elancourt, France
Tel: +33 130 68 89 30
taylor-hobson.france@ametek.com



Taylor Hobson Germany

Rudolf-Diesel-Straße 16,
D-64331 Weiterstadt, Germany
Tel: +49 6150 543 0
taylor-hobson.germany@ametek.com



Taylor Hobson Italy

Via Della Liberazione 24, 20068, Peschiera
Borromeo, Zelofoaramagno, Milan, Italy
Tel: +39 02 946 93401
taylor-hobson.italy@ametek.com



Taylor Hobson India

Divyasree NR Enclave, 4th Floor, Block A,
Plot No. 1, EPIP Industrial Area, Whitefield,
Bengaluru - 560066, India
Tel: +91 80 6782 3346
taylor-hobson.india@ametek.com



Taylor Hobson China

taylor-hobson-china.sales@ametek.com

Shanghai Office

Part A1, A4, 2nd Floor, Building No. 1, No. 526
Fute 3rd Road East, Pilot Free Trade Zone,
Shanghai, 200131, China
Tel: +86 21 5868 5111-110

Beijing Office

Western Section, 2nd Floor, Jing Dong Fang
Building (B10), No. 10, Jiu Xian Qiao Road,
Chaoyang District, Beijing, 100015, China
Tel: +86 10 8526 2111

Chengdu Office

No. 9-10, 10th floor, 9/F, High-tech Incubation
Park, No. 160, Jinyue West Road, Chengdu
610041, China
Tel: +86 28 8675 8111

Guangzhou Office

Room 810 Dongbao Plaza, No.767 East
Dongfeng Road, Guangzhou, 510600, China
Tel: +86 20 8363 4768



Taylor Hobson Japan

3F Shiba NBF Tower; 1-1-30, Shiba Daimon
Minato-ku, Tokyo 105-0012, Japan
Tel: +81 34400 2400
taylor-hobson.japan@ametek.com



Taylor Hobson Korea

#309, 3rd FL, Gyeonggi R&DB Center; 105,
Gwanggyo-ro, Yeongtong-gu, Suwon-si,
Gyeonggi-do, Korea, 16229
Tel: +82 31 888 5255
taylor-hobson.korea@ametek.com



Taylor Hobson Singapore

AMETEK Singapore, 10 Ang Mo Kio Street 65,
No. 05-12 Techpoint, Singapore 569059
Tel: +65 6484 2388 Ext 120
taylor-hobson.singapore@ametek.com



Taylor Hobson Thailand

89/45, Moo 15, Enterprise Park, Bangna-Trad
Road, Tambol Bangkaew, Amphur Bangplee,
Samutprakarn Province 10540, Thailand
Tel: +66 2 0127500 Ext 505
taylor-hobson.thailand@ametek.com



Taylor Hobson Taiwan

10F-5, No.120, Sec. 2, Gongdao Wu Rd.,
Hsinchu City 30072, Taiwan
Tel: +886 3 575 0099 Ext 301
taylor-hobson.taiwan@ametek.com



Taylor Hobson Mexico

Acceso III No. 16 Nave 3 Parque Ind. Benito
Juarez Queretaro, Qro. Mexico C.P. 76120
Tel: +52 442 426 4480
taylor-hobson.mexico@ametek.com



Taylor Hobson USA

27755 Diehl Road, Suite 300, Warrenville,
IL 60555, USA
Tel: +1 630 621 3099
taylor-hobson.usa@ametek.com



1100 Cassatt Road, Berwyn, PA 19312, USA
Email: info.corp@ametek.com
Web: www.ametek.com